



01-0101 01-0102



INTERPHONE VIDEO INTRACODE

INTRACODE VIDEO INTERCOM

INTRACODE VIDEO-GEGENSPRECHANLAGE

VIDEO-INTERCOM INTRACODE

INTERFONO VÍDEO INTRACODE



INTRATONE

INTRATONE  
ZI de Maunit 370 rue de Maunit  
85290 MORTAGNE SUR SEVRE  
FRANCE

AUDIO CALL / APPEL AUDIO / AUDIOANRUF / AUDIO CALL / LLAMADA DE AUDIO



**3G Module**  
**17-0101**



**4G IP Module**  
**17-0233**



VIDEO CALL / APPEL VIDEO / VIDEOANRUF / VIDEO CALL / VIDEO LLAMADA



3G Module 17-0101 

4G IP Module 17-0233 

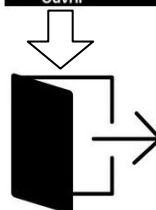
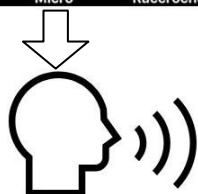
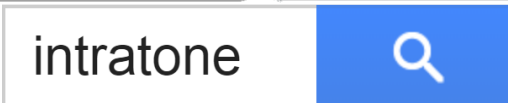

Ref : 01-0101 / 01-0102

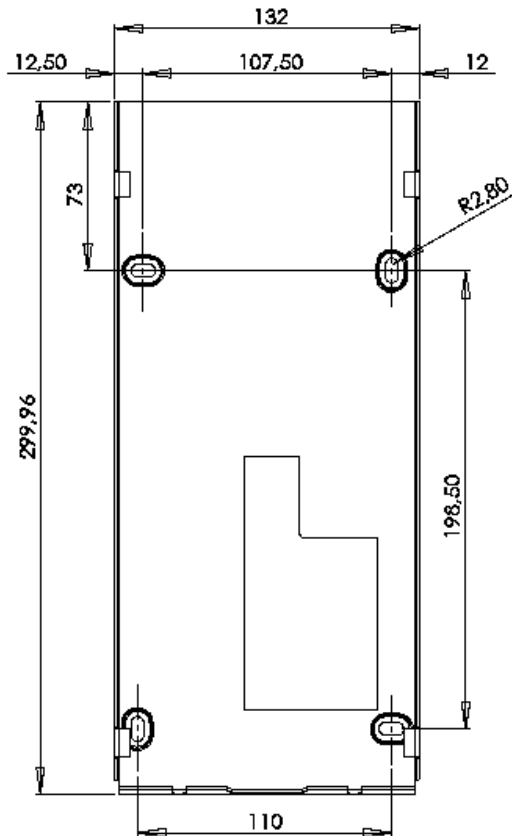
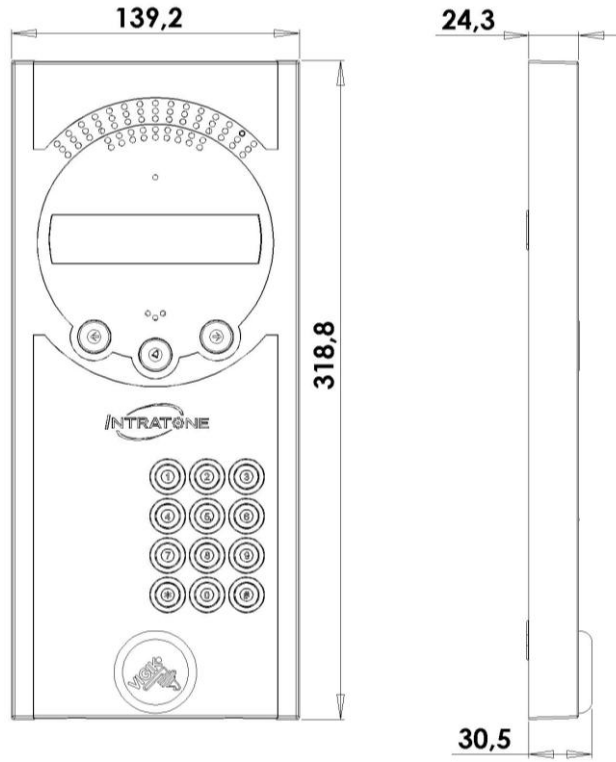
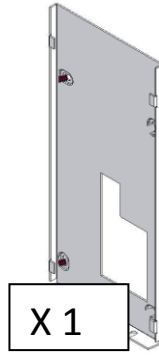
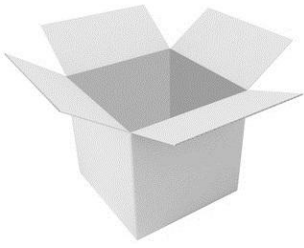

Montage / Fitting / Montage / Montage / Montaje

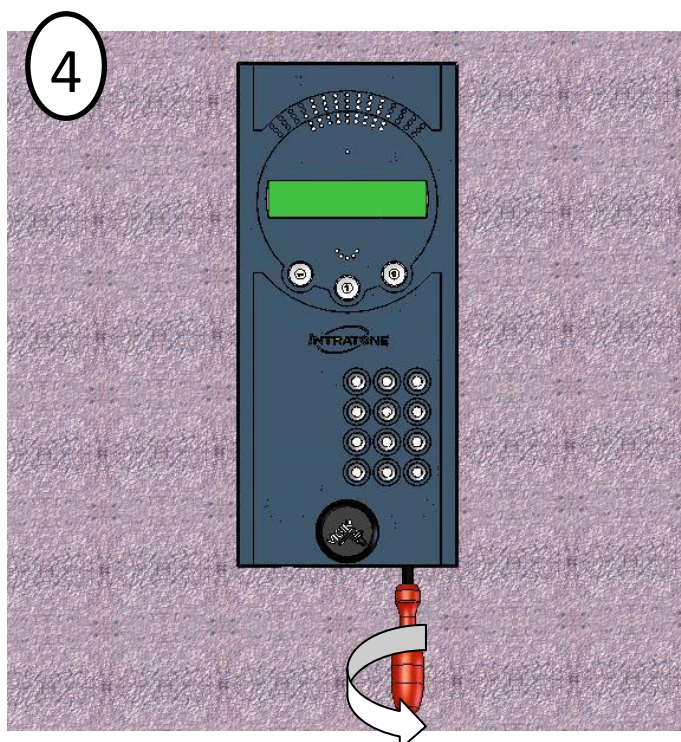
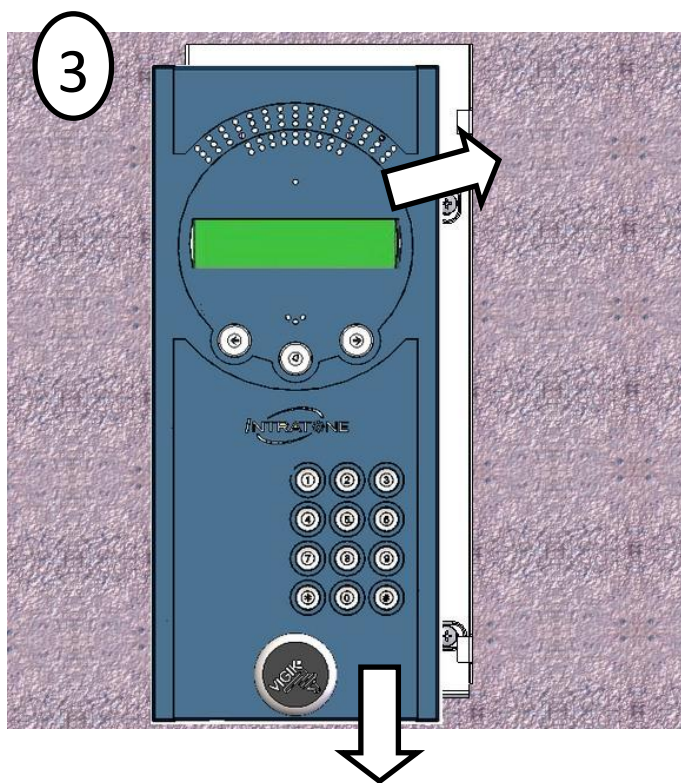
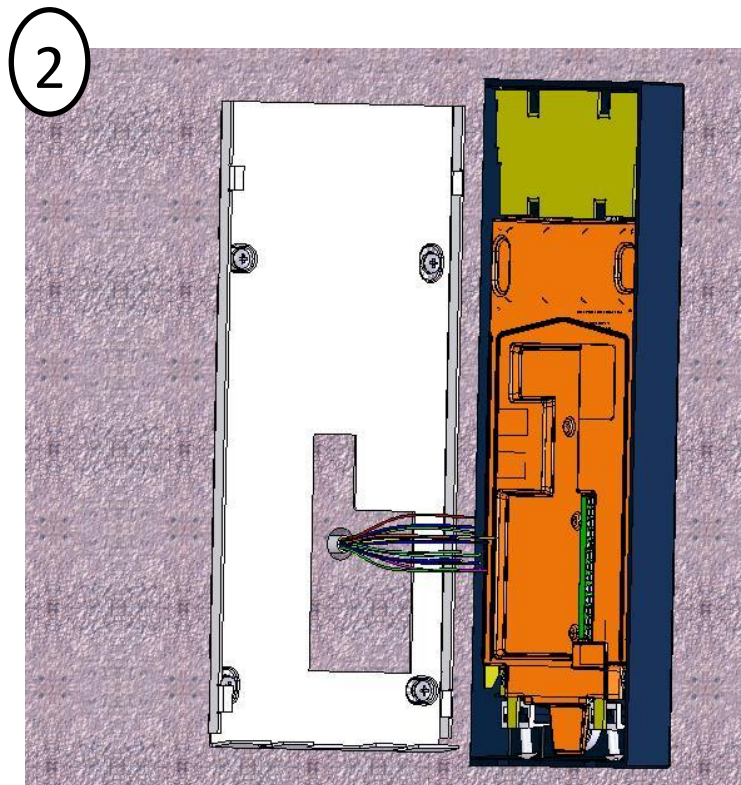
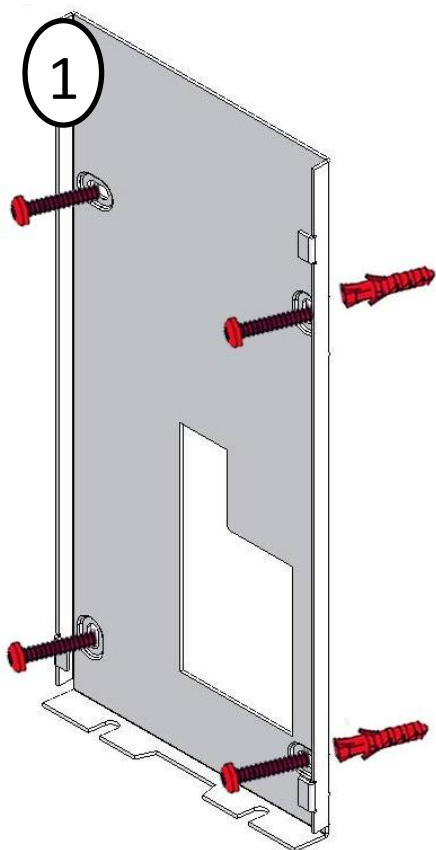



03-0102

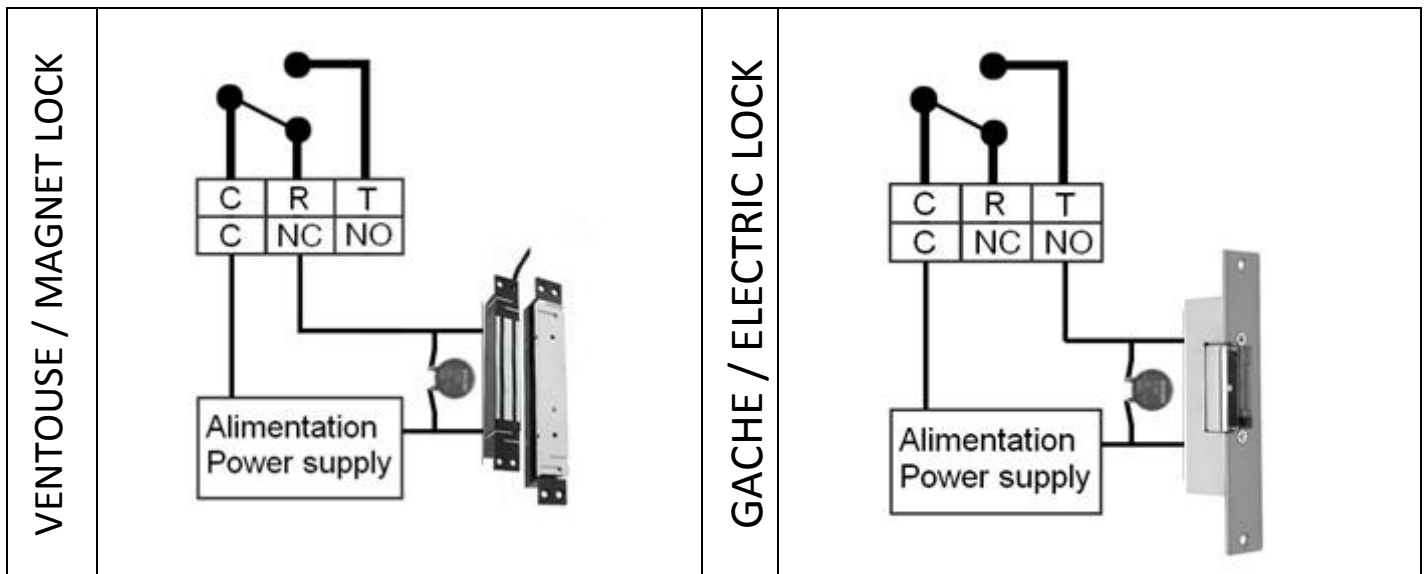
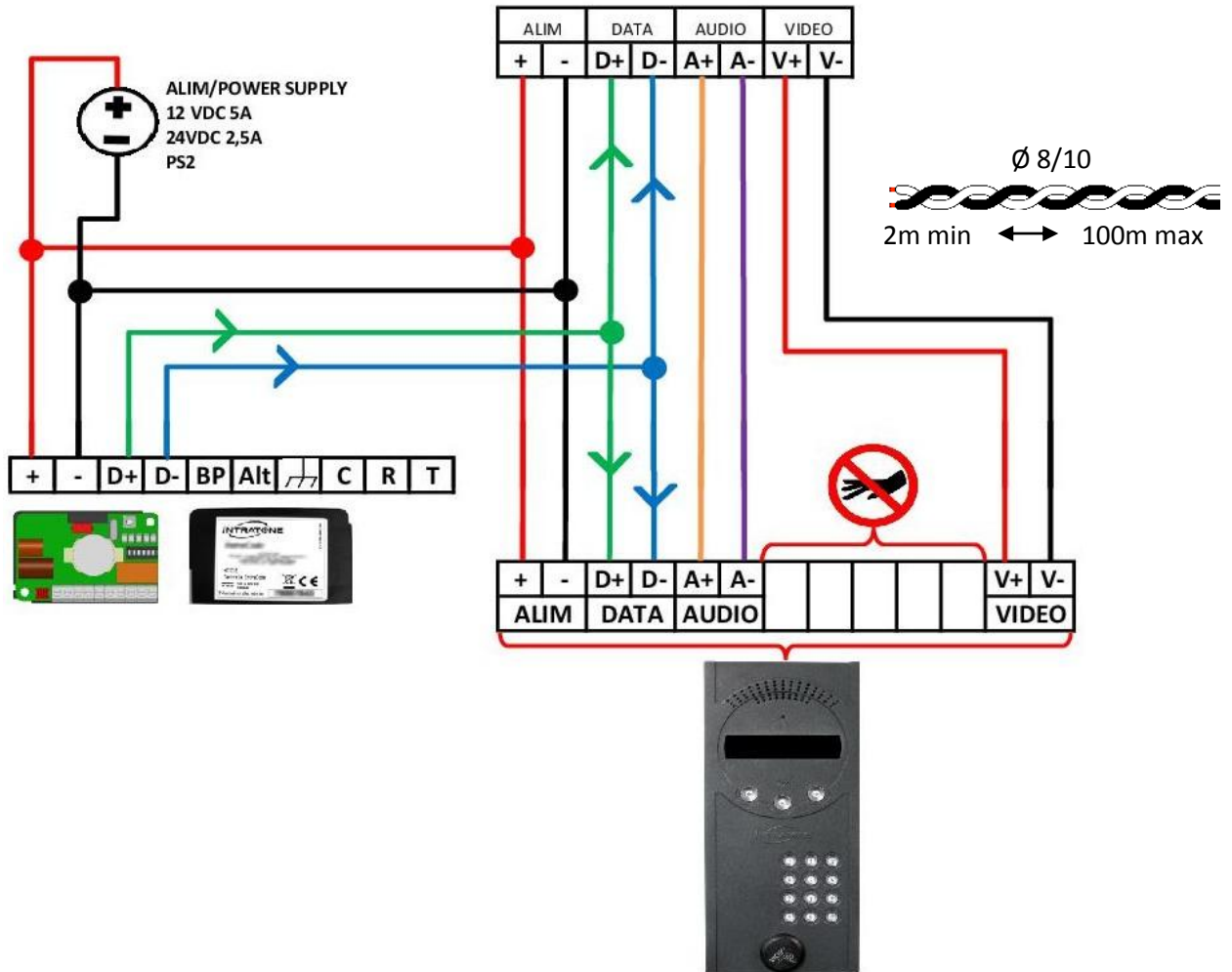

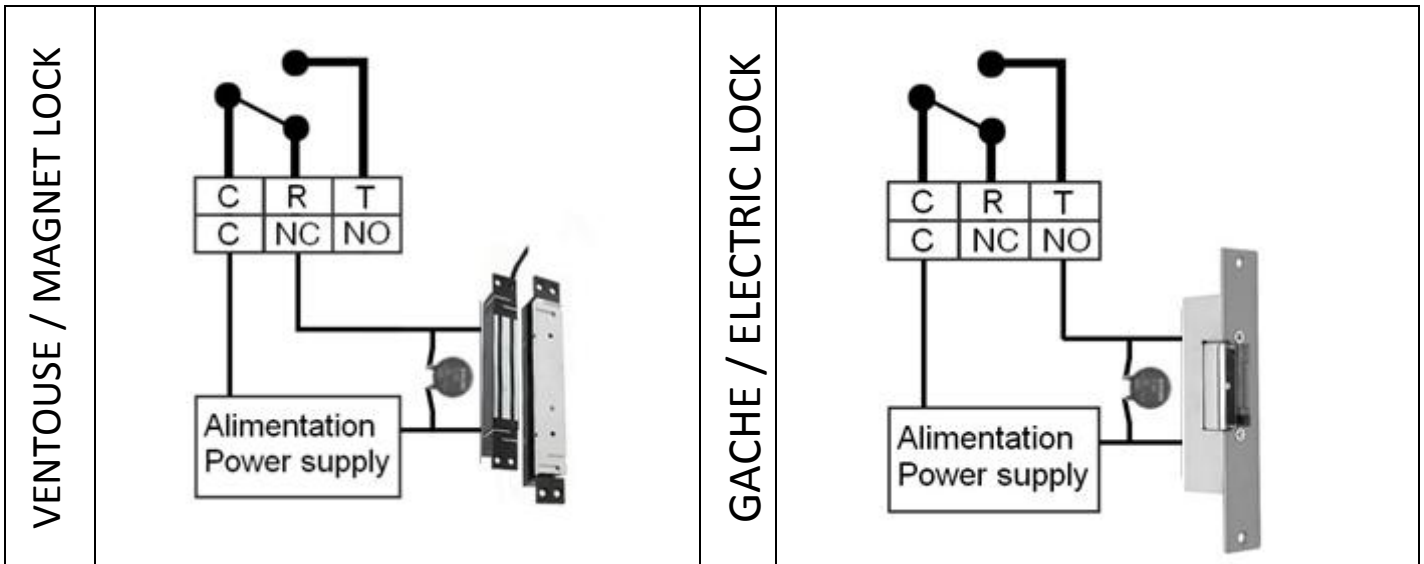
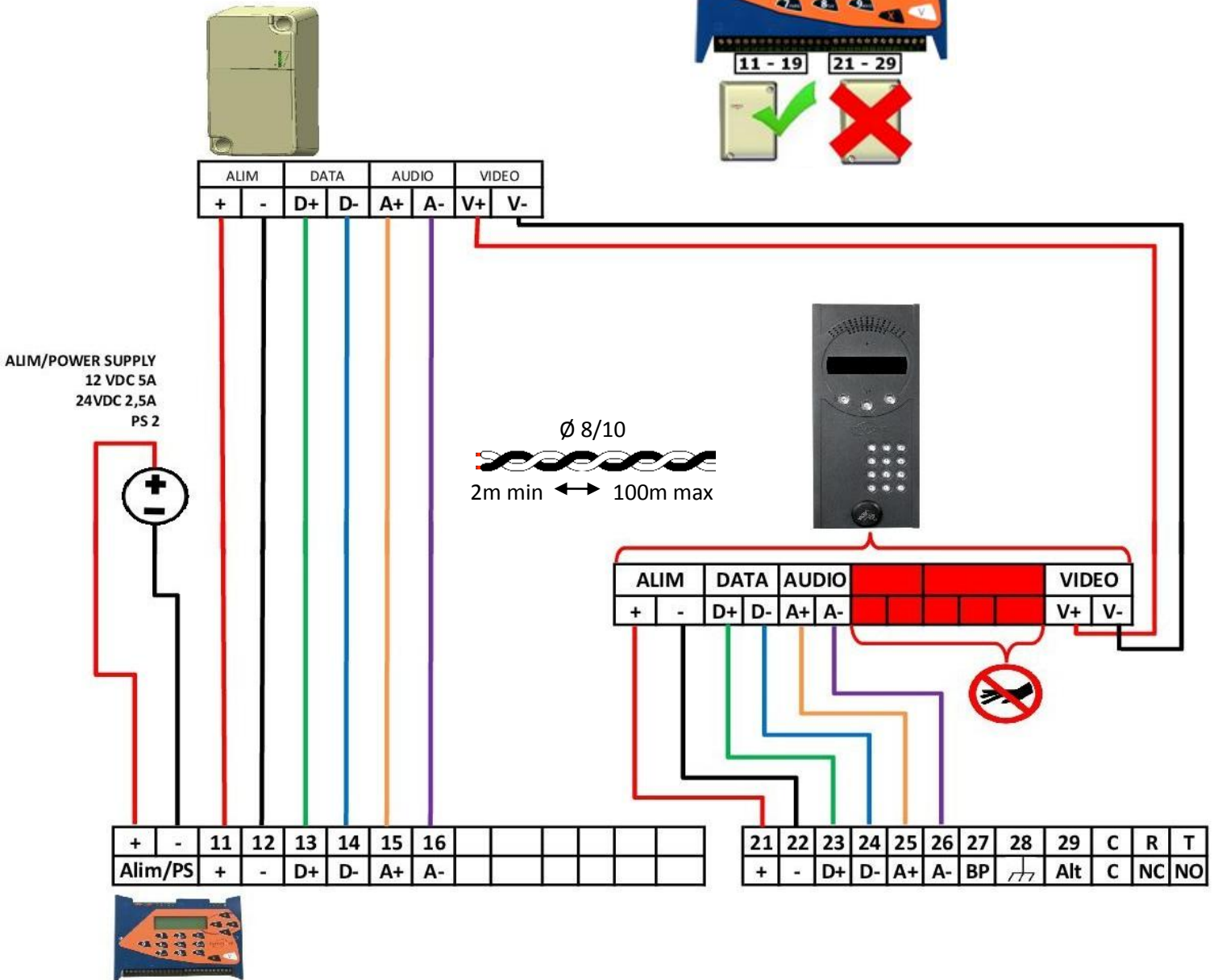

03-0101



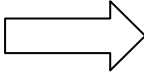

1 **Allez dans la résidence / Go to the residence / Gehe zur Wohnanlagen**

2 **Cliquer "Créer" et choisir votre interphone, nommez le  
Click "Create" and choose your intercom, name it  
Klicken Sie auf "Erstellen" und wählen Sie Ihre gegensprechanlage, benennen Sie sie**







**01-0101 / 01-0102  
HPICVIV1**

3 **Il faut maintenant "Configurer la centrale" / Now you need to "Central unit settings " /  
Jetzt müssen Sie " konfigurieren der Zentrale"**



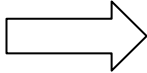

4 **Ajouter des badges , des appartements et des résidents avec « Créer » / Add fobs,  
apartments and residents with "Create" / Fügen Sie Badges, Apartments und Bewohner  
mit "Create" hinzu**



5 **Allez dans « Codes » pour créer des codes clavier / Go to "Codes" to create keypad codes  
/ Gehen Sie zu "Codes", um Tastaturcodes zu erstellen**

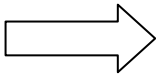

6 **Mettre à jour la résidence / Update the residence / Aktualisieren Sie immer die  
Wohnanlagen**





1

Ga naar de woning / Ir a la residencia



2

Klik op "Maken" en kies uw Video-intercom, noem het

Haga clic en "Crear" y elija su Interfono, asígnele el nombre

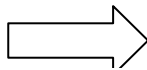

**01-0101 / 01-0102**  
*HPICVIV1*

3

Nu moet u "De centrale configureren"

Ahora necesitas "Configurar la central"

**De centrale configureren**

**Configurar la central**

4

Voeg badges, appartementen en bewoners toe met "Create"

Agregue insignias, apartamentos y residentes con "Crear"

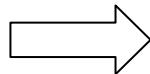

5

Ga naar "Codes" om toetsenbordcodes te maken

Vaya a "Códigos" para crear códigos de teclado

 **Codes**

 **Códigos**

6

Voordat u vertrekt, moet u de accommodatie altijd bijwerken

Antes de partir, siempre actualice la residencia

 **Residentie**  
 **Residenciales**

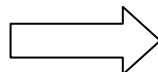

**Bijwerken**

**Actualizar**

Réception réseau / Network reception / Netzwerkkempfang / Netwerk ontvangst /  
Recepción de red

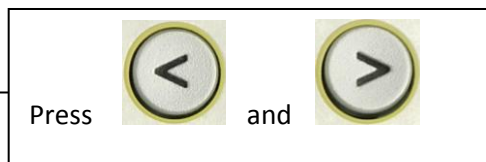

# RES 3G

	AUDIO CALL	VIDEO CALL
RES GSM	✓	✗
RES 3G	✓	✓
RES 4G	✓	✓

# NIV 17 3

Le premier chiffre donne le niveau sur 30 (Ici 17/30)	Le second chiffre donne le niveau sur 5 (Ici 3/5)
The first digit gives the level out of 30 (Here 17/30)	The second digit gives the level out of 5 (Here 3/5)
Die erste Ziffer gibt das Level von 30 (hier 17/30)	Die zweite Ziffer gibt die Stufe von 5 (hier 3/5)
Het eerste cijfer geeft het niveau uit 30 (hier 17/30)	Het tweede cijfer geeft het niveau van 5 (Here 3/5)
El primer dígito da el nivel de 30 (Aquí 17/30)	El segundo dígito da el nivel de 5 (Aquí 3/5)

## Dépannage

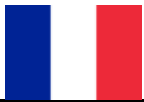
 <b>FR : Quelle est la panne ?</b>	<b>Comment résoudre la panne !</b>
Message sur afficheur : « Defaut de communication »	- Vérifier le câblage entre le bloc, la platine et la centrale : D+/D- - L'afficheur doit indiquer le message d'accueil.
Touches et ou écran LCD non rétro-éclairés	- Mauvais câblage sur les borniers + et ou –
Touches rétro-éclairées alors que l'afficheur ne l'est pas (ou l'inverse)	Contactez nos services techniques
Au passage d'un badge, la led du lecteur s'allume vert pourtant la porte ne s'ouvre pas.	- Relais de la centrale ne fonctionne pas. - Vérifier le câblage entre la centrale et la porte
L'interphone dit « Appel en cours » mais le résident n'entend pas le visiteur	Vérifier le câblage A+ / A-
La platine dit « Appel impossible » sans tonalité d'appel	Vérifier le câblage vers le bloc et niveau des leds Réseau téléphonique non disponible
Le résident ne voit pas le visiteur dans son téléphone	- Vérifier le câblage V+ / V-

### **Garanties de fonctionnement:**

L'Interphone Vidéo Intracode est garanti dans une plage de température comprise entre -20°C et +60°C et pour une humidité relative maximum de 70%.

Doit être posé selon le sens Haut / Bas préconisé sur l'appareil.

L'installation doit être réalisée par du personnel qualifié possédant les connaissances nécessaires à un montage sûr de l'équipement.

Ce kit comprend les éléments nécessaires pour assurer une installation sûre de l'équipement.



### **Recyclage du produit en fin de vie:**

L'Interphone Vidéo Intracode et ses accessoires ne doivent pas être mis au rebut avec les déchets municipaux non triés, mais doivent suivre la filière de collecte et de recyclage des produits DEEE (Déchets d'Equipements Electriques et Electroniques).



### **Déclaration de conformité simplifiée**

Le soussigné, COGEELEC, déclare que l'équipement radioélectrique du type contrôle d'accès pour l'habitat collectif est conforme à la directive 2014/53/UE (RED). Le texte complet de la déclaration UE de conformité est disponible à l'adresse internet suivante : [www.intratone.fr/documentation](http://www.intratone.fr/documentation)

## Help

 <b>EN : What is the failure ?</b>	<b>How to solve the problem!</b>
Message on display: "Communication fault"	- Check the wiring between the block, the board and the central unit: D + / D- - The display must indicate the greeting.
Keys and or LCD screen not backlit	- Bad wiring on + and or - terminal blocks
Backlit keys while the display is not (or vice versa)	Contact our technical services
When passing a badge, the LED of the reader turns green, but the door does not open.	- Relay of the central does not work. - Check wiring between the control panel and the door
The interphone says "Call in progress" but the resident does not hear the visitor	Review A + / A- wiring
The platinum says "Call impossible" without call tone	Check wiring to the block and leds level Phone network not available
The resident does not see the visitor in his phone	-Check wiring V + / V-

### **Warranty operating guarantees:**

The Intracode video intercom is guaranteed within a temperature range of -20°C and +60°C and at a relative humidity level not exceeding 70%.

**It must be installed according to the Top/Bottom directions given in these instructions and on the device.**

**The installation must be carried out by qualified personnel with the necessary knowledge for a safe assembly of the equipment.**

**This kit includes the necessary elements to ensure a safe installation of the equipment.**



### **End-of-life recycling of the product:**

The Intracode video intercom and its accessories must not be discarded with unsorted municipal waste, but must be disposed of via the WEEE (Waste Electrical and Electronic Equipment) collection and recycling system.



### **Simplified declaration of conformity**

The undersigned, COGELEC, declares that access control type radio equipment for collective housing is in compliance with Directive 2014/53 / EU (RED). The full text of the EU declaration of conformity is available at the following internet address: [www.intratone.fr/documentation](http://www.intratone.fr/documentation)

## Hilfe

 <b>DE : Was ist der Zusammenbruch?</b>	<b>Wie man das Problem löst!</b>
Meldung auf dem Display: "Kommunikationsfehler"	Überprüfen Sie die D + / D- Verdrahtung - Das Display muss die Begrüßung anzeigen.
Tasten und / oder LCD-Bildschirm nicht hinterleuchtet	- Schlechte Verdrahtung an + und oder - Klemmen
Hintergrundbeleuchtete Tasten während der Anzeige nicht (oder umgekehrt)	Kontaktieren Sie unseren technischen Service
Beim Übergeben eines Ausweises wird die LED des Lesers grün, aber die Tür öffnet sich nicht.	- Relais der Zentrale funktioniert nicht. - Überprüfen Sie die Verkabelung zwischen dem Bedienfeld und der Tür
Das Interphone sagt "Anruf läuft", aber der Bewohner hört den Besucher nicht	Überprüfen Sie die A + / A-Verdrahtung
Das Platin sagt "Anruf unmöglich" ohne Rufton	Überprüfen Sie die Verkabelung zum Block und zur LED-Ebene Das Telefonnetzwerk ist nicht verfügbar
Der Bewohner sieht den Besucher nicht in seinem Telefon	- Verdrahtung prüfen V + / V-

### **Funktionsgarantien:**

Der Betrieb des Intracode Video-Gegensprechanlage ist für eine Temperaturspanne zwischen -20 °C und +60 °C und für eine relative Luftfeuchtigkeit von 70 % gewährleistet.

**Muss wie auf dem Gegensprechanlage angegeben in der Richtung Oben/Unten eingebaut werden.**

**Die Installation muss von qualifiziertem Personal mit den notwendigen Kenntnissen für eine sichere Montage der Ausrüstung durchgeführt werden.**

**Dieses Kit enthält die notwendigen Elemente, um eine sichere Installation des Geräts zu gewährleisten.**



### **Entsorgung des ausgedienten Geräts:**



Das Intracode Video-Gegensprechanlage und sein Zubehör dürfen nicht mit unsortiertem Hausmüll entsorgt werden, sondern müssen an Sammel- und Recyclestellen für Elektro- und Elektronikgeräte-Abfall abgegeben werden.



### **Vereinfachte Konformitätserklärung**

Der Unterzeichnete, COGELEC, erklärt, dass funkgesteuerte Zugangskontrollgeräte für den kollektiven Wohnungsbau der Richtlinie 2014/53 / EU (RED) entsprechen. Der vollständige Text der EU-Konformitätserklärung ist unter folgender Internetadresse verfügbar: [www.intratone.fr/documentation](http://www.intratone.fr/documentation)

## Helpen

 <b>NL : Wat is de verdeling?</b>	<b>Hoe het probleem op te lossen!</b>
 Bericht op display: "Communicatiefout"	- Review D + / D- bedrading - Het display moet de begroeting aangeven.
Toetsen en of LCD-scherm niet verlicht	- Slechte bedrading op + en of - aansluitklemmen
Verlichte toetsen terwijl het display dat niet is (of omgekeerd)	Neem contact op met onze technische diensten
Bij het passeren van een badge wordt de LED van de lezer groen, maar de deur gaat niet open.	- Relay van de centrale werkt niet. - Controleer de bedrading tussen het bedieningspaneel en de deur
De intercom zegt "Lopend gesprek" maar de bewoner hoort de bezoeker niet	Review A + / A- bedrading
Het platina zegt "Bel onmogelijk" zonder beltoon	Controleer de bedrading naar het blok en het leds-niveau Telefoonnetwerk niet beschikbaar
De bewoner ziet de bezoeker niet in zijn telefoon	- Controleer de bedrading V + / V-

### **Werkingsgarantie:**

Het Video-intercom Intracode werkt bij temperaturen tussen -20 °C et +60 °C en bij een relatieve vochtigheid van ten hoogste 70%.

Moet gemonteerd worden met de juiste zijden naar boven en onder, zoals aangegeven op het intercom.

De installatie moet worden uitgevoerd door gekwalificeerd personeel met de nodige kennis voor een veilige montage van de apparatuur.

Deze set bevat de nodige elementen om een veilige installatie van de apparatuur te garanderen.



### **Recycling aan het einde van de levensduur:**

Het Video-intercom Intracode en zijn toebehoren mogen niet als restafval worden afgevoerd, maar moeten ingeleverd worden bij inzamelpunten voor elektrische of elektronische apparatuur.



### **Vereenvoudigde verklaring van overeenstemming**

Ondergetekende, COGELEC, verklaart dat radioapparatuur voor toegangscontrole voor collectieve huisvesting voldoet aan Richtlijn 2014/53 / EU (RED). De volledige tekst van de EU-conformiteitsverklaring is beschikbaar op het volgende internetadres: [www.intratone.fr/documentation](http://www.intratone.fr/documentation)

## Ayudar

 <b>ES : ¿Cuál es el colapso?</b>	<b>¿Cómo resolver el problema?</b>
Mensaje en pantalla: "Error de comunicación"	Revise el cableado D + / D- - La pantalla debe indicar el saludo.
Teclas y / o pantalla LCD no retroiluminada	- Mal cableado en + y o - bloques de terminales
Teclas retroiluminadas mientras la pantalla no está (o viceversa)	Póngase en contacto con nuestros servicios técnicos
Al pasar una insignia, el LED del lector se ilumina en verde, pero la puerta no se abre.	- El relevo de la central no funciona. - Verifique el cableado entre el panel de control y la puerta
El interfono dice "Llamada en curso" pero el residente no oye al visitante	Revise el cableado A + / A-
El platino dice "Llamar imposible" sin tono de llamada	Revise el cableado al bloque y nivel de leds La red telefónica no está disponible
El residente no ve al visitante en su teléfono	- Revisar el cableado V + / V-

### **Garantías de funcionamiento:**

El Interfono vídeo Intracode está garantizado en una franja de temperatura entre los -20 °C y los +60 °C y con una humedad relativa máxima del 70 %.

Debe colocarse con el sentido Arriba / Abajo que se indica en el interfono.

La instalación debe ser llevada a cabo por personal calificado con los conocimientos necesarios para un montaje seguro del equipo.

Este kit incluye los elementos necesarios para garantizar una instalación segura del equipo.



### **Reciclaje del producto una vez concluida su vida útil:**

No deseche el Interfono vídeo Intracode, ni los accesorios que incluye, junto con los residuos municipales orgánicos. Debe seguir el procedimiento de recogida y reciclaje dispuesto para los productos RAEE (Residuos de dispositivos Eléctricos y Electrónicos).



### **Declaración simplificada de conformidad**

El abajo firmante, COGELEC, declara que los equipos de radio de control de acceso para viviendas colectivas cumplen con la Directiva 2014/53 / UE (RED). El texto completo de la declaración de conformidad de la UE está disponible en siguiente dirección de internet:

[www.intratone.fr/documentation](http://www.intratone.fr/documentation)

